

Ersatzteilliste

(1.291-227.0) BDS 51/180 C Adv *EU

Inhaltsverzeichnis

BDS 51/180 C Adv *EU (1.291-227.0)	3
ETL BDS 43+51/180 C (5.970-161.0)	4
10 Griff	5
11 Griff Bedieneinheit	6
12 Griff Verstellung	9
36 Set Achsenaufnahme Ersatz (6.681-115.0)	12
20 Buerstenkopf	14
21 Buerstenkopf	15
22 Buersten	17
30 ABS Tank	19

BDS 51/180 C Adv *EU (1.291-227.0)

POS	Artikelnr.	Beschreibung	Anzahl	Einheit
0	5.970-161.0	ETL BDS 43+51/180 C	1.000	ST

ETL BDS 43+51/180 C (5.970-161.0)

POS	Beschreibung	Anzahl	Einheit
10	Griff	1.000	ST
20	Buerstenkopf	1.000	ST
30	ABS Tank	1.000	ST

10 Griff

POS	Beschreibung	Anzahl	Einheit
11	Griff Bedieneinheit	1.000	ST
12	Griff Verstellung	1.000	ST

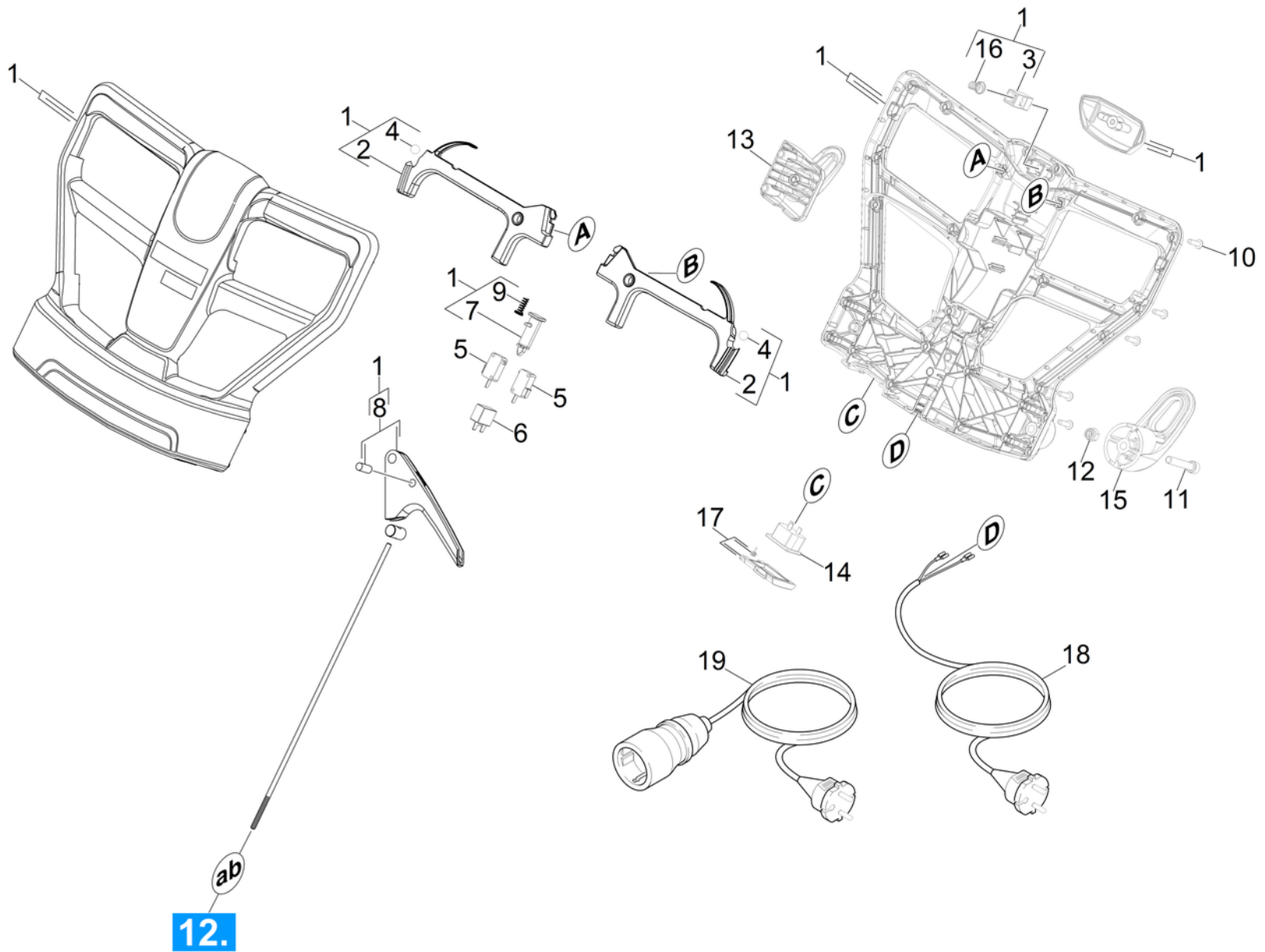

11 Griff Bedieneinheit

- * Flachsteckerhülse vollisoliert
Tyco 2-520274-2 4,8x0,8mm
- * Faston Fully Insulated
Tyco 2-520274-2 4,8x0,8mm
- ** Flachsteckerhülse vollisoliert
Tyco 2-520263-4 6,3x0,8mm
- ** Faston Fully Insulated
Tyco 2-520263-4 6,3x0,8mm
- *** Flachstecker vollisoliert
Tyco 3-520106-2 6,3x0,8mm
- *** Faston Tabs Fully Insulated
Tyco 3-520106-2 6,3x0,8mm

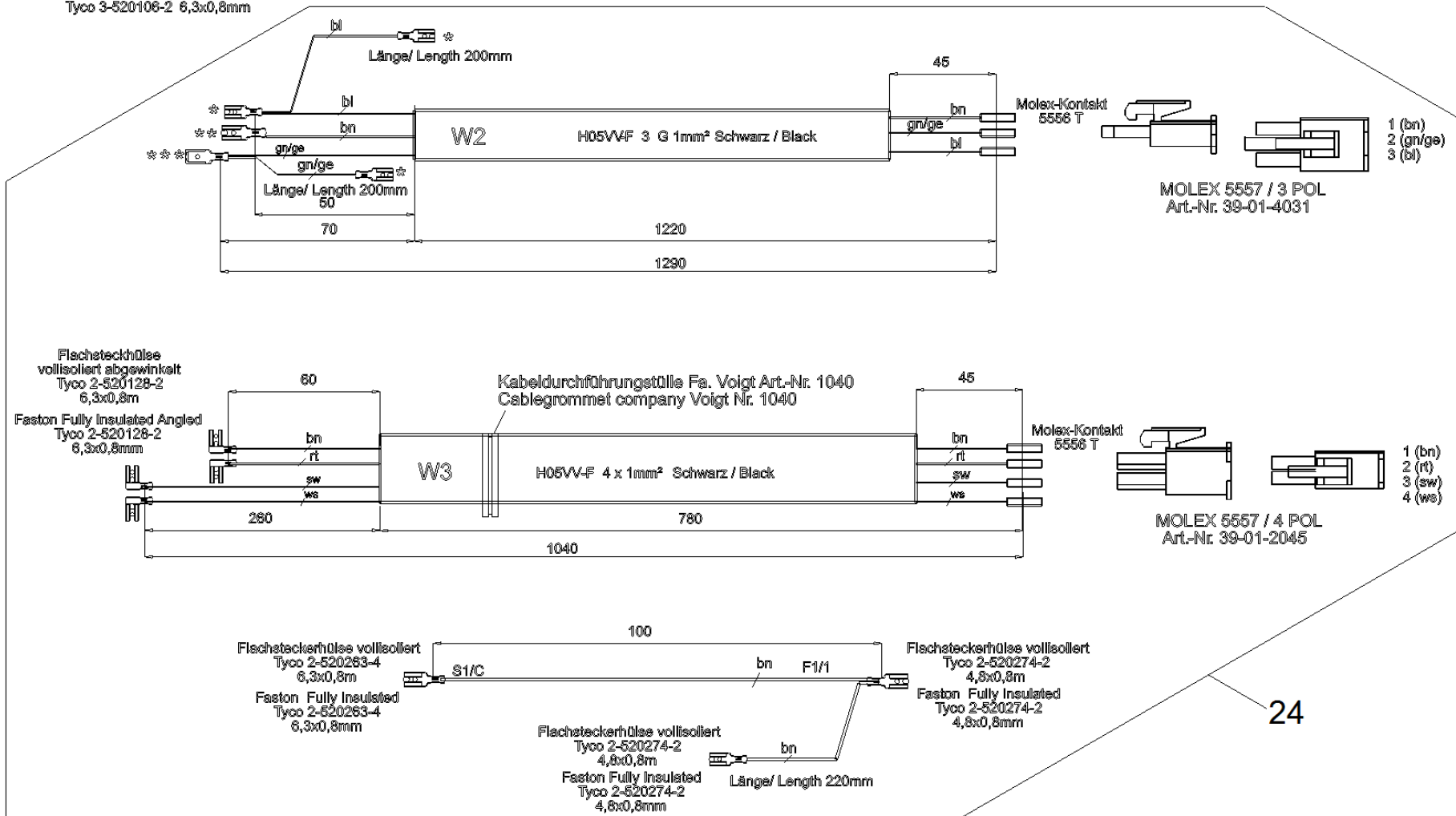

11 Griff Bedieneinheit

POS	Artikelnr.	Beschreibung	Anzahl	Einheit
1	6.681-112.0	Set Bedieneinheit Ersatz	1.000	ST
2	6.681-113.0	Set Hebel Buerstenantrieb Ersatz	1.000	ST
3	5.050-879.0	Hebel Entriegelung	1.000	ST
4	7.401-917.0	Kugel 10,0 G100-1.4301 DIN 5401	2.000	ST
5	6.630-426.0	Hauptschalter	2.000	ST
6	6.630-543.0	Motorschutzschalter 8A	1.000	ST
7	5.050-433.0	Stoessel Schalter	1.000	ST
8	6.681-114.0	Set Griff Verstellung Ersatz	1.000	ST
9	5.332-944.0	Feder konisch	2.000	ST
10	7.303-108.0	Schraube 5x20 -10.9-R2R (In6Rd)	23.000	ST
11	7.306-049.0	Zyl.Schr. M 8x45-8.8-A2E ISO 4762	1.000	ST
12	7.311-510.0	6kt-Mutter M 8-8-A2E ISO 7040	1.000	ST
13	5.044-020.0	Griff	1.000	ST
14	6.686-527.0	Geraetesteckdose Griff	1.000	ST
15	8.633-561.0	Haken	1.000	ST
16	5.332-944.0	Feder konisch	1.000	ST
17	6.681-132.0	Set Deckel Steckdose	1.000	ST
18	6.649-982.0	Kabel mit Stecker	1.000	ST
	Positionstext1: 1.291-221.0 / -222.0			
18	6.650-204.0	Kabel mit Stecker	1.000	ST
	Positionstext1: 1.291-226.0 / -227.0 / -237.0			
19	6.647-942.0	Verlaengerungskabel	1.000	ST
	Positionstext1: 1.291-226.0 / -227.0 / -237.0			
19		Verlaengerungskabel 15,5m	1.000	ST
	Positionstext1: 1.291-221.0 / -222.0			
24	4.821-121.0	Kabelbaum BDS	1.000	ST

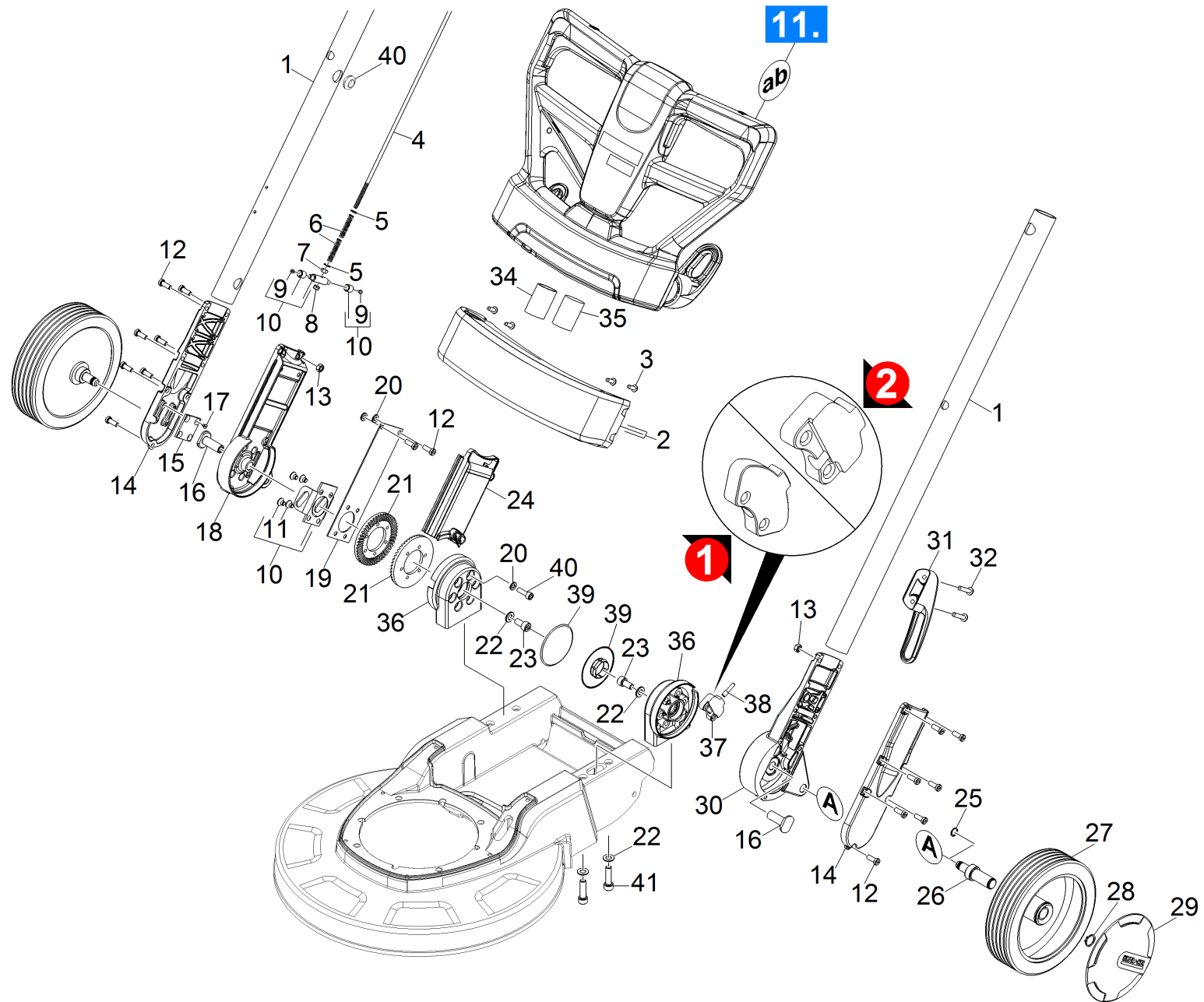

12 Griff Verstellung

POS	Artikelnr.	Beschreibung	Anzahl	Einheit	Bemerkung	Fußnotentext
1	5.033-602.0	Rohr Handgriff	2.000	ST		
2	6.681-117.0	Set Strebe Ersatz	1.000	ST		
3	7.303-107.0	Schraube 5x16 -10.9-P2R (K-In6Rd)	8.000	ST		
4	5.107-306.0	Stange	1.000	ST		
5	7.312-052.0	Scheibe 5 -A2 ISO 7089	2.000	ST		
6	5.332-042.0	Druckfeder	2.000	ST		
7	7.311-002.0	6kt-Mutter M5 -8-A2E ISO 4032	1.000	ST		
8	7.311-421.0	6kt-Mutter M 5-04-A2E ISO 10511	1.000	ST		
9	7.305-035.0	Senkschraube M 4x10-A2-70-SCHW (IN6RD)	2.000	ST		
10	6.681-116.0	Set Blech Ersatz	1.000	ST		
11	7.305-051.0	Senkschraube M6x8 -A2-70 (In6Rd)	4.000	ST		
12	7.306-031.0	Schraube M 6x16-A2-70 DIN 7984	23.000	ST		
13	7.311-003.0	6kt-Mutter M6 -8-A2E ISO 4032	4.000	ST		
14	5.044-963.0	Deckel Winkel	2.000	ST		
15	5.039-062.0	Blech	1.000	ST		
16	5.034-906.0	Achse	2.000	ST		
17	7.305-252.0	Senkschraube M 4x8-4.8-A2E ISO 7046-1 H	4.000	ST		
18	5.044-961.0	Winkel rechts	1.000	ST		
19	5.039-061.0	Federblech	1.000	ST		
20	7.312-003.0	Scheibe 6 -200HV-A3E ISO 7090	2.000	ST		
21	5.044-988.0	Zahnkranz	2.000	ST		
22	7.312-004.0	Scheibe 8 -200HV-A3E ISO 7090	6.000	ST		
23	7.306-040.0	Zyl.Schr. M8x16 -8.8-A2E ISO4762	4.000	ST		
24	5.050-966.0	Abdeckung	1.000	ST		
25	7.343-300.0	Sicherungsscheibe 7-A2 DIN 6799	2.000	ST		
26	5.034-795.0	Achse Transportrad	2.000	ST		
27	6.435-196.0	Rad D 180	2.000	ST		
28	7.343-005.0	Sicherungsring 16x1-FST-PHR DIN 471	2.000	ST		
29	5.064-392.0	Radkappe grau	2.000	ST		
30	5.044-959.0	Winkel links	1.000	ST		ZUSAMMEN MIT VERSION 2/POS. 37+38 BESTELLEN
31	8.621-895.0	Haken	1.000	ST		

12 Griff Verstellung

POS	Artikelnr.	Beschreibung	Anzahl	Einheit	Bemerkung	Fußnotentext
32	7.306-158.0	Zyl.Schr. M 5x20-A4-70 ISO 4762	2.000	ST		
34	6.632-523.0	Kondensator start 60µF	1.000	ST		
35	6.632-524.0	Kondensator run 20µF	1.000	ST		
36	6.681-115.0	Set Achsenaufnahme Ersatz	1.000	ST		
37	5.044-244.0	Platte Verriegelung	1.000	ST	VERSION 2	
37	5.044-019.0	Platte Verriegelung	1.000	ST	VERSION 1	
38	5.034-928.0	Stift Verriegelung	1.000	ST	VERSION 1	
38	5.034-013.0	Stift Verriegelung	1.000	ST	VERSION 2	
39	5.033-724.0	Abdeckung Aufnahme Achse	2.000	ST		
40	7.306-022.0	Zyl.Schr. M 6x20-8.8-A2E ISO4762	12.000	ST		
41	7.306-043.0	Zyl.Schr. M8x30 -8.8-A2E ISO 4762	4.000	ST		

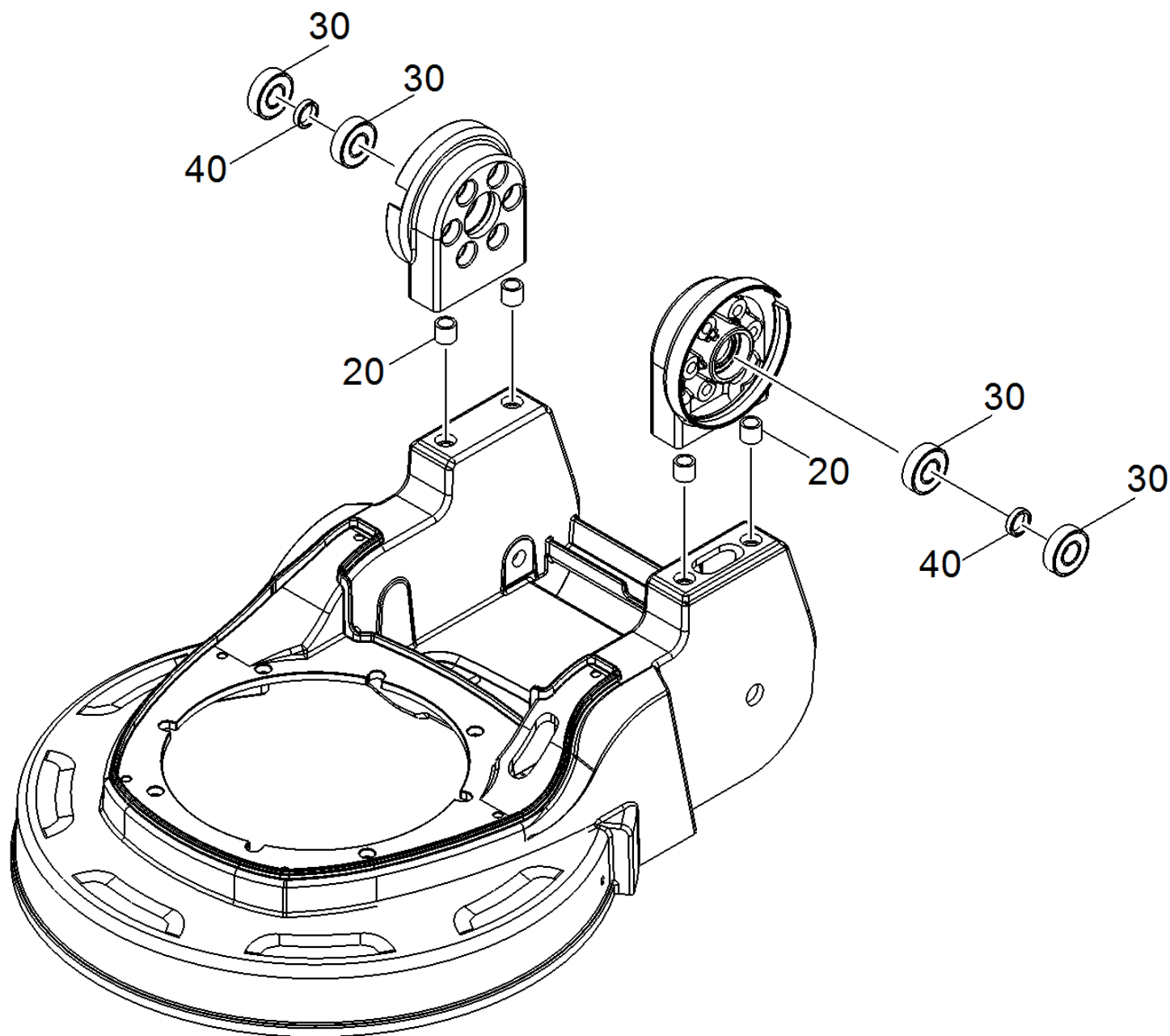

36 Set Achsenaufnahme Ersatz (6.681-115.0)

POS	Artikelnr.	Beschreibung	Anzahl	Einheit
20	5.110-495.0	Huelse	4.000	ST
30	6.401-363.0	Rillenkugellager	4.000	ST
40	5.122-481.0	Buchse	2.000	ST

20 Buerstenkopf

POS	Beschreibung	Anzahl	Einheit
21	Buerstenkopf	1.000	ST
22	Buersten	1.000	ST

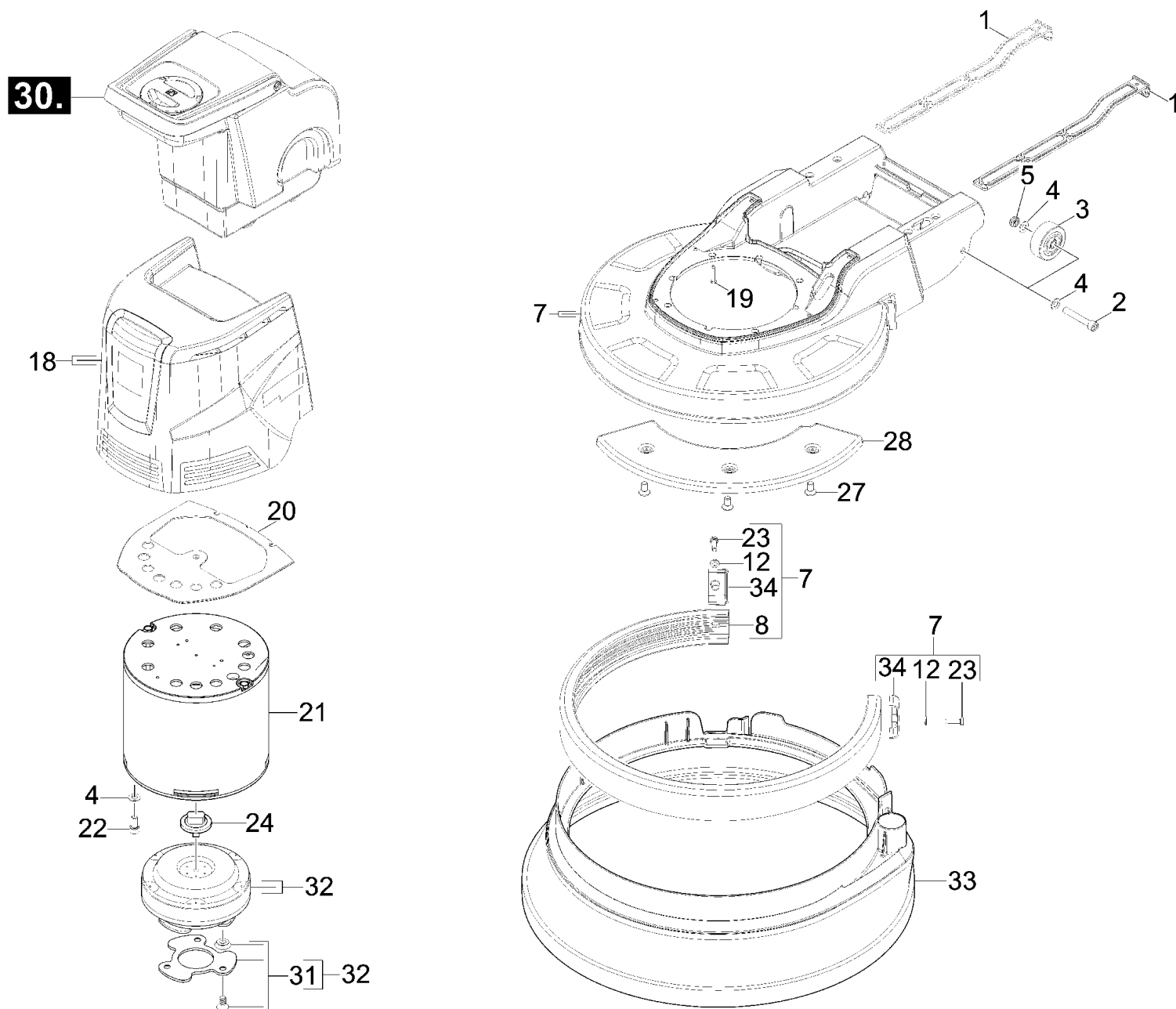

21 Buerstenkopf

POS	Artikelnr.	Beschreibung	Anzahl	Einheit
1	5.050-983.0	Kantenschutz BDS 430 / 510	2.000	ST
2	7.306-039.0	Zyl.Schr. M8x50 -8.8-A2E ISO 4762	2.000	ST
3	6.435-867.0	Rad	2.000	ST
4	7.312-004.0	Scheibe 8 -200HV-A3E ISO 7090	12.000	ST
5	7.311-427.0	6kt-Mutter M8 -04-A2E ISO 10511	2.000	ST
7	6.681-118.0	Buerstendeck Ersatz BDS 430	1.000	ST
7	6.681-122.0	Buerstendeck fuer Ersatz BDS 510	1.000	ST
8	6.681-123.0	Set Rammschutz fuer Ersatz BDS 510	1.000	ST
8	6.681-119.0	Set Rammschutz BDS 430 Ersatz	1.000	ST
12	7.312-003.0	Scheibe 6 -200HV-A3E ISO 7090	4.000	ST
18	4.066-394.0	Haube kpl. BDS	1.000	ST
19	7.303-207.0	Schraube 4x25-A2-70 (In6Rd)	6.000	ST
20	5.123-187.0	Trennblech BDS 430 / 510	1.000	ST
21	6.613-192.0	Motor 1400W 230V 50Hz	1.000	ST
22	7.306-119.0	Zyl.Schr. M8x12 -A2-70 ISO 4762	4.000	ST
23	7.304-536.0	6kt-Schraube M 6x20-A4-70 ISO 4017	2.000	ST
24	6.613-475.0	Kupplungsstueck nur fuer Ersatz Metall	1.000	ST
27	7.305-637.0	Senkschraube M8x16-A2-70 ISO 10642	1.000	ST
28	5.044-996.0	Gewicht BDS 430	1.000	ST
31	6.681-006.0	Set Mitnehmer Buerste BDS	1.000	ST
32	6.454-089.0	Getriebe i = 1:8 180rpm BDS 230V	1.000	ST
33	4.071-223.0	Absaugring kpl. 43cm/17" Adv	1.000	ST

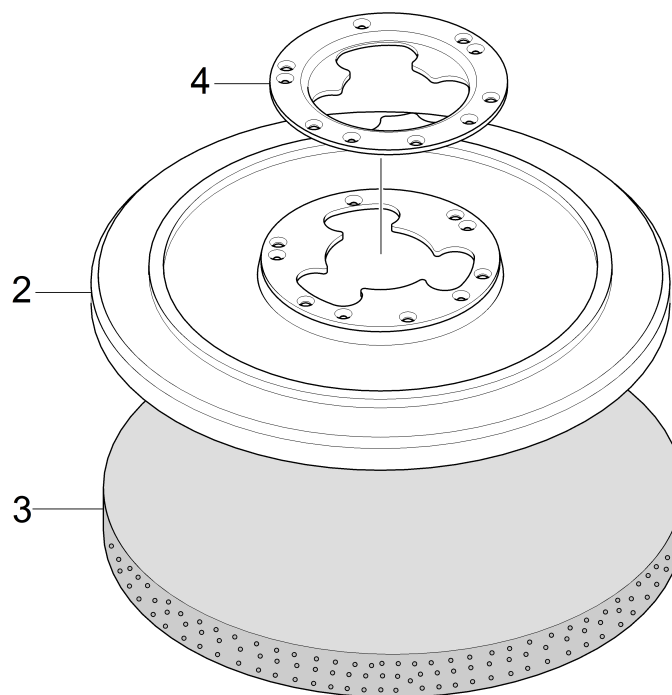
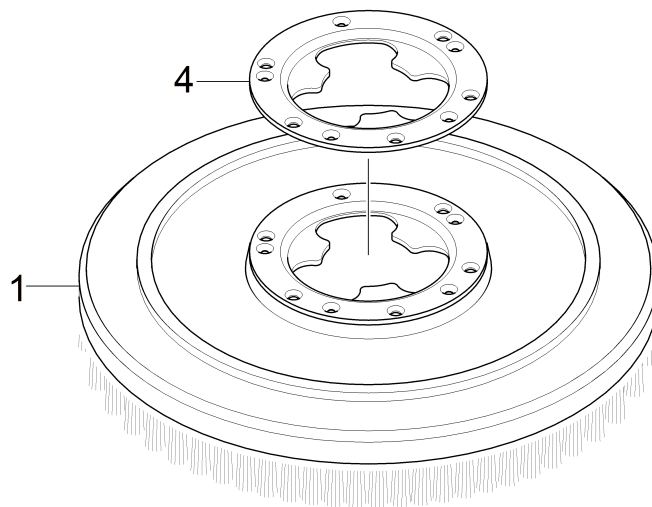

22 Buersten

POS	Artikelnr.	Beschreibung	Anzahl	Einheit	Bemerkung
1	6.371-266.0	Buerste Shampoo BDS 510	1.000	ST	BDS 51
1	6.369-895.0	Schrubbuerste rot (old colour white)	1.000	ST	BDS 43
1	6.371-265.0	Buerste schwarz	1.000	ST	BDS 51
1	6.371-206.0	Schrubbuerste BDS 510	1.000	ST	BDS 51
1	6.369-896.0	Buerste Shampoo BDS 43/150/DUO C	1.000	ST	BDS 43
1	6.369-898.0	Buerste schwarz (old colour grey)	1.000	ST	BDS 43
2	6.371-208.0	Treibteller BDS 510	1.000	ST	BDS 51
2	6.369-899.0	Treibteller LOW SPEED	1.000	ST	BDS 43
3	6.371-270.0	Kristallisationspad	1.000	ZSA	BDS 51
3	6.371-271.0	Pad Mikrofaser	1.000	ZSA	BDS 51
3	6.905-386.0	Kristallisationspad	1.000	ZSA	BDS 43
3	6.371-261.0	Diamantpad gelb Set 5x Ø508	1.000	ST	BDS 51
3	6.905-526.0	Pad Mikrofaser	1.000	ZSA	BDS 43
3	6.371-240.0	Diamantpad gruen Set 5x Ø508	1.000	ST	BDS 51
3	6.369-911.0	Pad Kristallisation silber BDS 43/150/DU	1.000	ZSA	BDS 43
3	6.371-260.0	Diamantpad weiss Set 5x Ø508	1.000	ST	BDS 51
3	6.371-256.0	Diamantpad weiss Set 5x Ø432	1.000	ST	BDS 43
3	6.371-257.0	Diamantpad gelb Set 5x Ø432	1.000	ST	BDS 43
4	5.474-049.0	Mitnehmer fuer Scheibenbuersten	1.000	ST	

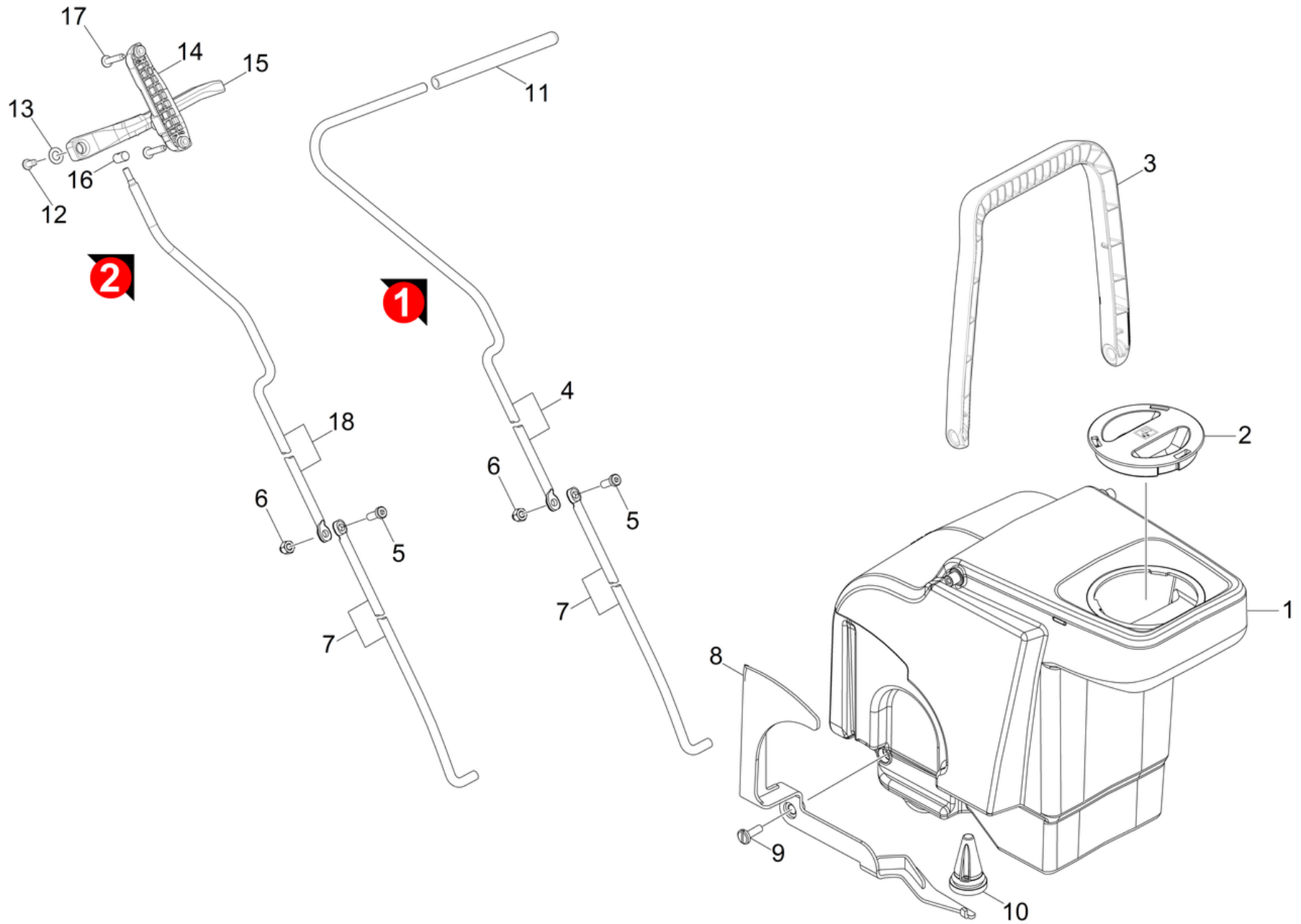

30 ABS Tank

POS	Artikelnr.	Beschreibung	Anzahl	Einheit
1	5.071-226.0	Tank BDS 430 / 510	1.000	ST
2	5.051-294.0	Deckel Tank	1.000	ST
3	5.321-003.0	Griff Tank BDS	1.000	ST
4	4.642-000.0	UBS Handgriff Wasserablass	1.000	ST
5	7.306-031.0	Schraube M 6x16-A2-70 DIN 7984	1.000	ST
6	7.311-622.0	Hutmutter M 6-A2 DIN 986	1.000	ST
7	5.027-332.0	Stab Wasser unten	1.000	ST
8	4.481-284.0	Hebel Wasserventil kpl.	1.000	ST
9	7.306-264.0	Fl.Schr. M6x10 -5.8 bruerniert DIN 923	1.000	ST
10	4.034-220.0	Ventil kpl. Tank BDS	1.000	ST
11	6.645-007.0	Ueberzug Griff Tank	1.000	ST
12	7.303-274.0	Schraube 5x12 -A2-70 (In6Rd)	1.000	ST
13	7.343-107.0	Passscheibe 8x14x1 -A2 DIN 988	1.000	ST
14	5.033-019.0	Halterung Hebel Wasserablass	1.000	ST
15	5.033-018.0	Hebel Wasserablass	1.000	ST
16	5.317-451.0	Bolzen	1.000	ST
17	7.303-109.0	Schraube 5x25 -10.9-R2R (In6Rd)	2.000	ST
18	5.033-020.0	Stab Wasser oben	1.000	ST