

IVM 40/24-2 H

Der IVM 40/24-2 H ist ein 2-motoriger, mobiler und robuster Mittelklasse-Industriestaubsauger für feinen und groben Schmutz. Inklusive Staubklasse H Zertifizierung.



Bestell-Nr.

9.989-908.0

- Nach Staubklasse H zertifiziert
- Antistatische Ausstattung
- Edelstahl

Technische Daten

EAN-Code		4054278943916
Stromart	Ph / V / Hz	1 / 220 - 240 / 50 - 60
Luftmenge	l/s	106
Vakuum	mbar	225
Behälterinhalt	l	40
Aufnahmeleistung	kW	2,3
Aufnahmetyp		Elektrisch
Filterfläche	m ²	1,5
Anschlussnennweite		DN 70
Zubehöرنennweite		DN 50 / DN 40
Schalldruckpegel	dB(A)	77
Gewicht ohne Zubehör	kg	39,8
Gewicht inkl. Verpackung	kg	41,8
Abmessungen (L × B × H)	mm	645 × 655 × 1150

Ausstattung

Filter	Patronenfilter
Sekundärfilter	■
Zubehör im Lieferumfang	nein
Behälterentleerung	Absetzfahrgestell

■ Im Lieferumfang enthalten.



2 Gebläsemotoren

- Hohe Saugleistung und Robustheit.

Fahrbarer Edelstahlbehälter

- Der abgesetzte Behälter kann bequem aus dem Fahrgestell entnommen und zur Entsorgung/Entleerung gefahren werden.

ZUBEHÖR VON IVM 40/24-2 H 9.989-908.0

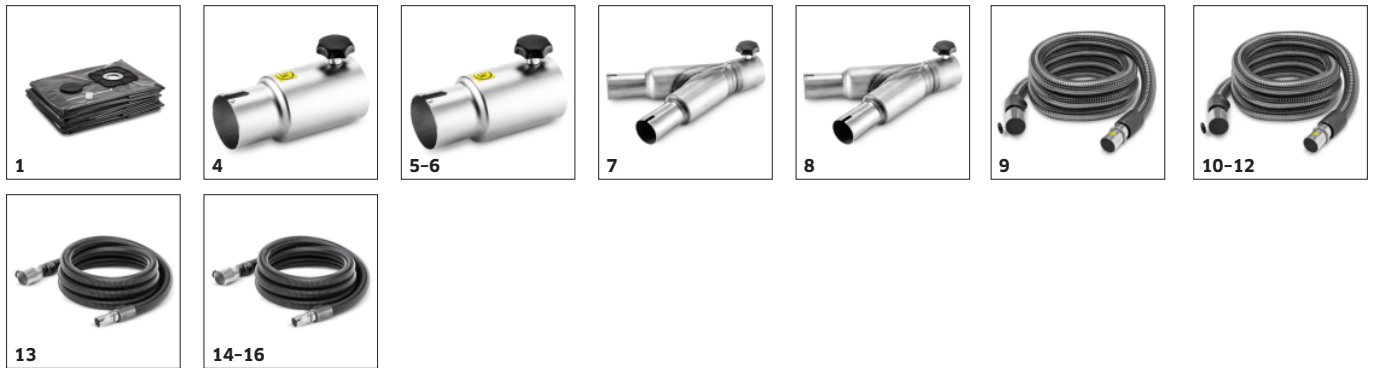

		Bestell-Nr.	Beschreibung	
FILTER T / NT				
Sicherheitsfiltersets/-säcke				
Sicherheitsfiltersack, 5 x , NT 75/1	1	6.904-420.0	Zur staubfreien / staubarmen Entleerung in Verbindung mit dem Behälter 4.070-930.0, mit Entsorgungsbeutel, elektrisch leitend. Geprüft und zugelassen für die Staubklasse H.	<input type="checkbox"/>
FILTER				
Taschen- /Sternfilter				
Sternfilter PE/PTFE M 1,6m ² , versiegelte Nähte	2	9.990-018.0		<input type="checkbox"/>
Patronenfilter				
Patronenfilter PE H 1,6m ²	3	9.993-005.0		<input type="checkbox"/>
ADAPTER / REDUZIERSTÜCKE / VERTEILER				
Reduzierstücke / Vergrößerungen				
Reduzierung Edelstahl DN70 auf DN50	4	9.989-712.0		<input type="checkbox"/>
Reduzierung Edelstahl DN70 auf DN40	5	9.989-713.0		<input type="checkbox"/>
Reduzierung Edelstahl DN50 auf DN40	6	9.989-893.0		<input type="checkbox"/>
Verteiler				
Y-Verteiler Edelstahl AISI 304 DN70 auf DN50	7	9.989-894.0		<input type="checkbox"/>
Y-Verteiler Edelstahl AISI 304 DN70 auf DN40	8	9.989-895.0		<input type="checkbox"/>
SCHLÄUCHE				
PVC-Schläuche				
Schlauch PVC, Edelstahl-Schlauchanschlussstücke, DN40 3 m	9	9.989-962.0		<input type="checkbox"/>
Schlauch PVC, Edelstahl-Schlauchanschlussstücke, DN40 5 m	10	9.989-963.0		<input type="checkbox"/>
Schlauch PVC, Edelstahl-Schlauchanschlussstücke, DN50 3 m	11	9.989-964.0		<input type="checkbox"/>
Schlauch PVC, Edelstahl-Schlauchanschlussstücke, DN50 5 m	12	9.989-965.0		<input type="checkbox"/>
EVA-Schläuche				
Schlauch EVA, Edelstahl-Schlauchanschlussstücke, DN40 3 m	13	9.989-982.0		<input type="checkbox"/>
Schlauch EVA DN40 5 m	14	9.989-983.0		<input type="checkbox"/>

■ Im Lieferumfang enthalten. □ Mögliches Zubehör.

ZUBEHÖR VON IVM 40/24-2 H 9.989-908.0

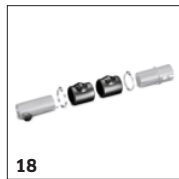

	Bestell-Nr.	Beschreibung	
SCHLÄUCHE			
EVA-Schläuche			
Schlauch EVA DN50 3 m	15	9.989-984.0	<input type="checkbox"/>
Schlauch EVA DN50 5 m	16	9.989-985.0	<input type="checkbox"/>
Schlauch Montagesets			
Schlauch Montageset Edelstahl AISI 304 DN40	17	9.989-986.0	<input type="checkbox"/>
Schlauch Montageset Edelstahl AISI 304 DN50	18	9.989-987.0	<input type="checkbox"/>
PU-Schläuche			
Schlauch PU DN40 3 m	19	9.989-966.0	<input type="checkbox"/>
Schlauch PU DN40 5 m	20	9.989-967.0	<input type="checkbox"/>
Schlauch PU DN50 3 m	21	9.989-968.0	<input type="checkbox"/>
Schlauch PU DN50 5 m	22	9.989-969.0	<input type="checkbox"/>
Schlauch PU FDA DN40 3 m	23	9.989-970.0	<input type="checkbox"/>
Schlauch PU FDA DN40 5 m	24	9.989-971.0	<input type="checkbox"/>
Schlauch PU FDA DN40 15 m	25	9.989-972.0	<input type="checkbox"/>
Schlauch PU FDA DN50 3 m	26	9.989-973.0	<input type="checkbox"/>
Schlauch PU FDA DN50 5 m	27	9.989-974.0	<input type="checkbox"/>
Schlauch PU FDA DN50 15 m	28	9.989-975.0	<input type="checkbox"/>

Mögliches Zubehör.

ZUBEHÖR VON IVM 40/24-2 H 9.989-908.0



29



30-33



35



36



38



39



40



41



42

	Bestell-Nr.	Beschreibung	
SCHLÄUCHE			
ME-PU-Schläuche			
Schlauch ME DN40 3 m	29	9.989-976.0	<input type="checkbox"/>
Schlauch ME DN40 5 m	30	9.989-977.0	<input type="checkbox"/>
Schlauch ohne Anschluss ME DN40 15 m	31	9.989-978.0	<input type="checkbox"/>
Schlauch ME DN50 3 m	32	9.989-979.0	<input type="checkbox"/>
Schlauch ME DN50 5 m	33	9.989-980.0	<input type="checkbox"/>
Schlauch ohne Anschluss ME DN50 15 m	34	9.989-981.0	<input type="checkbox"/>
HANDGRIFFE			
Handgriff Edelstahl AISI 304 gebogen DN40 auf DN-F40	35	9.989-896.0	<input type="checkbox"/>
Handgriff Edelstahl AISI 304 gebogen DN50 auf DN-F50	36	9.989-897.0	<input type="checkbox"/>
Handgriff Edelstahl AISI 304 gerade DN40 auf DN-F40	37	9.989-898.0	<input type="checkbox"/>
Handgriff Edelstahl AISI 304 gerade DN50 auf DN-F50	38	9.989-899.0	<input type="checkbox"/>
Handgriff Karbon DN-F40	39	9.989-916.0	<input type="checkbox"/>
Handgriff Karbon DN-F50	40	9.989-917.0	<input type="checkbox"/>
Handgriff Karbon 110° DN-F40	41	9.989-918.0	<input type="checkbox"/>
Handgriff Karbon 110° DN-F50	42	9.989-919.0	<input type="checkbox"/>

Mögliches Zubehör.

ZUBEHÖR VON IVM 40/24-2 H 9.989-908.0

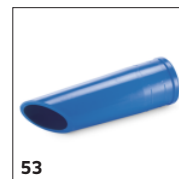
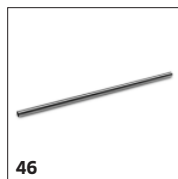
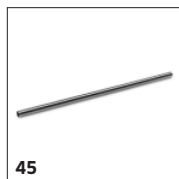
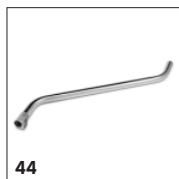
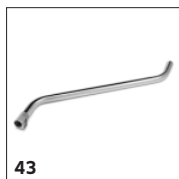

	Bestell-Nr.	Beschreibung	
SAUGROHRE			
Saugrohr Edelstahl AISI 304 DN40 auf DN-F40	43	9.989-912.0	<input type="checkbox"/>
Saugrohr Edelstahl AISI 304 DN50 auf DN-F50	44	9.989-913.0	<input type="checkbox"/>
Saugrohr Karbon 1500 mm DN-F40 konisch	45	9.989-920.0	<input type="checkbox"/>
Saugrohr Karbon 1500 mm DN-F50 konisch	46	9.989-921.0	<input type="checkbox"/>
Saugrohr High Temperature Aluminium DN-F40 1000 mm	47	9.989-928.0	<input type="checkbox"/>
Saugrohr High Temperature Aluminium DN-F50 1000 mm	48	9.989-929.0	<input type="checkbox"/>
Saugrohr High Temperature Aluminium DN-F50 2000 mm	49	9.989-930.0	<input type="checkbox"/>
	50	9.989-931.0	<input type="checkbox"/>
Saugrohr High Temperature Aluminium DN-F40 3000 mm	51	9.989-932.0	<input type="checkbox"/>
Saugrohr High Temperature Aluminium DN-F50 3000 mm	52	9.989-933.0	<input type="checkbox"/>
DÜSEN			
Standarddüsen			
Standarddüse Silikon FDA DN-F40 blau	53	9.989-835.0	<input type="checkbox"/>
Standarddüse Silikon FDA DN-F40 grün	54	9.989-836.0	<input type="checkbox"/>
Standarddüse Silikon FDA DN-F40 rot	55	9.989-837.0	<input type="checkbox"/>
Standarddüse Silikon FDA DN-F40 transparent	56	9.989-838.0	<input type="checkbox"/>

Mögliches Zubehör.

ZUBEHÖR VON IVM 40/24-2 H 9.989-908.0



	Bestell-Nr.	Beschreibung	
DÜSEN			
Standarddüsen			
Standarddüse Silikon FDA DN-F40 weiß	57	9.989-839.0	<input type="checkbox"/>
Standarddüse Silikon FDA DN-F40 gelb	58	9.989-840.0	<input type="checkbox"/>
Standarddüse Silikon FDA DN-F50 blau	59	9.989-841.0	<input type="checkbox"/>
Standarddüse Silikon FDA DN-F50 grün	60	9.989-842.0	<input type="checkbox"/>
Standarddüse Silikon FDA DN-F50 rot	61	9.989-843.0	<input type="checkbox"/>
Standarddüse Silikon FDA DN-F50 transparent	62	9.989-844.0	<input type="checkbox"/>
Standarddüse Silikon FDA DN-F50 weiß	63	9.989-845.0	<input type="checkbox"/>
Standarddüse Silikon FDA DN-F50 gelb	64	9.989-846.0	<input type="checkbox"/>
Bodendüsen			
Bodendüse Edelstahl AISI 304 DN-F40 blau	65	9.989-861.0	<input type="checkbox"/>
Bodendüse Edelstahl AISI 304 DN-F50 blau	66	9.989-862.0	<input type="checkbox"/>
Bodendüse Edelstahl AISI 304 DN-F40 grün	67	9.989-863.0	<input type="checkbox"/>
Bodendüse Edelstahl AISI 316L grün	68	9.989-864.0	<input type="checkbox"/>
Bodendüse Edelstahl AISI 316L DN-F40 rot	69	9.989-865.0	<input type="checkbox"/>
Bodendüse Edelstahl AISI 316L DN-F50 rot	70	9.989-866.0	<input type="checkbox"/>

Mögliches Zubehör.

ZUBEHÖR VON IVM 40/24-2 H 9.989-908.0



	Bestell-Nr.	Beschreibung	
DÜSEN			
Bodendüsen			
Bodendüse Edelstahl AISI 316L DN-F 40 transparent	71	9.989-867.0	<input type="checkbox"/>
Bodendüse Edelstahl AISI 316L DN-F50 transparent	72	9.989-868.0	<input type="checkbox"/>
Bodendüse Edelstahl AISI 316L DN-F40 weiß	73	9.989-869.0	<input type="checkbox"/>
Bodendüse Edelstahl AISI 316L DN-F50 weiß	74	9.989-870.0	<input type="checkbox"/>
Bodendüse Edelstahl AISI 316L DN-F40 gelb	75	9.989-871.0	<input type="checkbox"/>
Bodendüse Edelstahl AISI 316L DN-F50 gelb	76	9.989-872.0	<input type="checkbox"/>
Bodendüse Edelstahl AISI 316L DN-F40	77	9.989-914.0	<input type="checkbox"/>
Bodendüse Edelstahl AISI 316L DN-F50	78	9.989-915.0	<input type="checkbox"/>
Bodendüse Edelstahl 400 mm DN-F40	79	9.989-934.0	<input type="checkbox"/>
Bodendüse Edelstahl 400 mm DN-F50	80	9.989-935.0	<input type="checkbox"/>
Bodendüse Aluminium 400 mm DN-F40	81	9.989-936.0	<input type="checkbox"/>
Bodendüse Aluminium 400 mm DN-F50	82	9.989-937.0	<input type="checkbox"/>
Nutendüsen biegsam			
Nutendüse biegsam Silikon FDA DN-F50 transparent	83	9.989-847.0	<input type="checkbox"/>
Nutendüse biegsam Silikon FDA DN-F40 transparent	84	9.989-848.0	<input type="checkbox"/>

Mögliches Zubehör.

ZUBEHÖR VON IVM 40/24-2 H 9.989-908.0



	Bestell-Nr.	Beschreibung	
DÜSEN			
Flächendüsen			
Flächendüse Silikon FDA DN-F40 blau	85	9.989-849.0	<input type="checkbox"/>
Flächendüse Silikon FDA DN-F50 blau	86	9.989-850.0	<input type="checkbox"/>
Flächendüse Silikon FDA DN-F40 grün	87	9.989-851.0	<input type="checkbox"/>
Flächendüse Silikon FDA DN-F50 grün	88	9.989-852.0	<input type="checkbox"/>
Flächendüse Silikon FDA DN-F40 rot	89	9.989-853.0	<input type="checkbox"/>
Flächendüse Silikon FDA DN-F50 rot	90	9.989-854.0	<input type="checkbox"/>
Flächendüse Silikon FDA DN-F40 transparent	91	9.989-855.0	<input type="checkbox"/>
Flächendüse Silikon FDA DN-F50 transparent	92	9.989-856.0	<input type="checkbox"/>
Flächendüse Silikon FDA DN-F40 weiß	93	9.989-857.0	<input type="checkbox"/>
Flächendüse Silikon FDA DN-F50 weiß	94	9.989-858.0	<input type="checkbox"/>
Flächendüse Silikon FDA DN-F40 gelb	95	9.989-859.0	<input type="checkbox"/>
Flächendüse Silikon FDA DN-F50 gelb	96	9.989-860.0	<input type="checkbox"/>
BÜRSTEN			
Pinselbürsten			
Pinselbürste FDA ø 75 mm DN-F40 blau	97	9.989-873.0	<input type="checkbox"/>
Pinselbürste FDA ø 75 mm DN-F50 blau	98	9.989-874.0	<input type="checkbox"/>

Mögliches Zubehör.

ZUBEHÖR VON IVM 40/24-2 H 9.989-908.0



	Bestell-Nr.	Beschreibung	
BÜRSTEN			
Pinselfürsten			
Pinselfürste FDA ø 75 mm DN-F40 grün	99	9.989-875.0	<input type="checkbox"/>
Pinselfürste FDA ø 75 mm DN-F50 grün	100	9.989-876.0	<input type="checkbox"/>
Pinselfürste FDA ø 75 mm DN-F40 rot	101	9.989-877.0	<input type="checkbox"/>
Pinselfürste FDA ø 75 mm DN-F50 rot	102	9.989-878.0	<input type="checkbox"/>
Pinselfürste FDA ø 75 mm DN-F40 weiß	103	9.989-879.0	<input type="checkbox"/>
Pinselfürste FDA ø 75 mm DN-F50 weiß	104	9.989-880.0	<input type="checkbox"/>
Pinselfürste FDA ø 75 mm DN-F40 gelb	105	9.989-881.0	<input type="checkbox"/>
Pinselfürste FDA ø 75 mm DN-F50 gelb	106	9.989-882.0	<input type="checkbox"/>
ZUBEHÖR SETS			
Feststoffe / Stäube			
Standard Kit Backofenreinigung DN50	107	9.989-938.0	<input type="checkbox"/>
Standard Kit Backofenreinigung DN40	108	9.989-939.0	<input type="checkbox"/>
Standard Kit Lebensmittel DN40	109	9.989-940.0	<input type="checkbox"/>
Standard Kit Lebensmittel DN50	110	9.989-941.0	<input type="checkbox"/>
Standard Kit Überkopfreinigung DN40	111	9.989-942.0	<input type="checkbox"/>
Standard Kit Überkopfreinigung DN50	112	9.989-943.0	<input type="checkbox"/>

Mögliches Zubehör.